

Data sheet | Item number: 704-2024

Interface module for system wiring; Pluggable connector per DIN 41651; Male connector; 20-pole; 16-channel digital input or output; 2-wire connection; Double-deck PCB terminal blocks; in mounting carrier

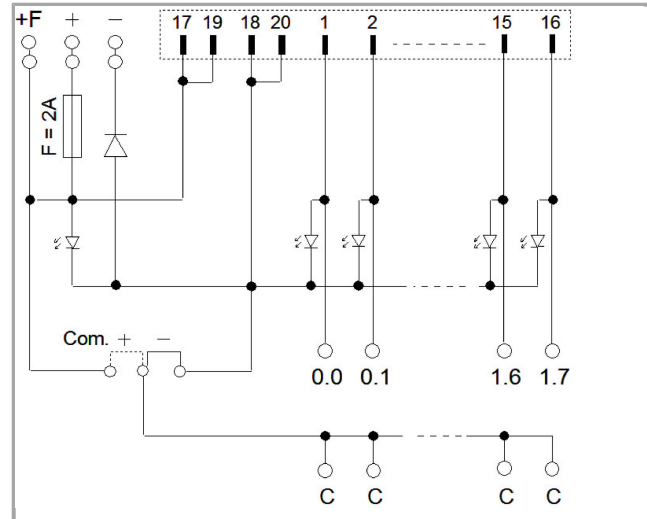

704-2024

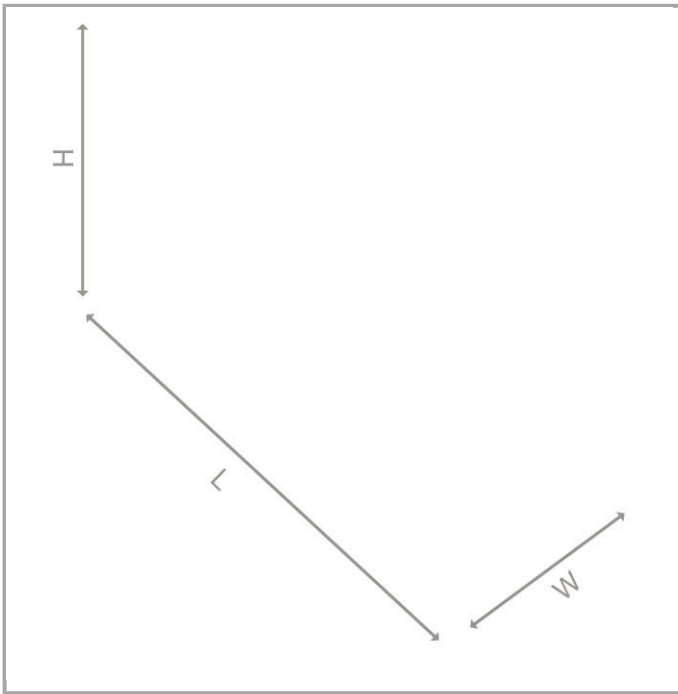

**Data****Electrical data**

In-/Outputs	16-channel digital in- or output
Circuit type	2-conductor termination
Nominal operating voltage	DC 24 V
Operating voltage range	±10 %
Power consumption (status indication)	5 mA
Total current	2 A
Limiting continuous current	1 A
Status indication	LED green (channel) LED yellow (power supply)
Internal fuse	2 A

Safety and protection:

Rated voltage	50 V
Rated impulse voltage	0.8 kV
Pollution degree	2

Connection data

No. of poles	20
Connection type (1)	System
No. of poles 1	20
Pluggable connector	Pluggable connector per DIN 41651; male connector
Mating direction	Vertical



Connection type (2)	Field
No. of poles 2	32
Design 2	PCB terminal blocks, double-deck
Connection technology 2	CAGE CLAMP®
WAGO terminal 2	WAGO 736 Series
Solid conductor (2)	0.08 ... 2.5 mm ² / 28 ... 12 AWG
Strip length (2)	5 ... 6 mm / 0.2 ... 0.24 inch
Connection type (3)	Supply
No. of poles 3	6
Design 3	PCB terminal blocks, double-deck
Connection technology 3	CAGE CLAMP®
WAGO terminal 3	WAGO 736 Series
Solid conductor (3)	0.08 ... 2.5 mm ² / 28 ... 12 AWG
Fine-stranded conductor (3)	0.08 ... 2.5 mm ² / 28 ... 12 AWG
Strip length (3)	5 ... 6 mm / 0.2 ... 0.24 inch
Note (conductor cross-section)	12 AWG: THHN, THWN

Geometrical Data

Width	85 mm / 3.346 inch
Height from upper-edge of DIN-35 rail	50 mm / 1.969 inch
Depth	85 mm / 3.346 inch

Mechanical data

Type of mounting	DIN-35 rail
Housing design	Mounting carrier

Material Data

Fire load	0 MJ
Weight	112.26 g

Environmental Requirements

Surrounding air (operating) temperature	-20 ... 50 °C
Surrounding air (storage) temperature	-40 ... 70 °C
Relative humidity	≤ 85% (non condensing)

Commercial data













Product Group	30 ()
Country of origin	FR
GTIN	4050821220657







Customs Tariff No.

8536901000





Compatible products

wiring and connectors

	Item no.: 706-100/1300-200 Connection cable; 20-pole; Pluggable connector per DIN 41651; open-ended; Length: 2 m; Conductor cross-section: 0.14 mm ² ; UR components	/ 1300-200	706-100
	Item no.: 706-100/1300-400 Connection cable; 20-pole; Pluggable connector per DIN 41651; open-ended; 4m; Conductor cross-section: 0.14 mm ² ; UR components	/ 1300-400	706-100
	Item no.: 706-2300/100-100 System cable; for Siemens S7-300; 2 x 16 digital inputs; Length: 1 m (1 MOhm); Conductor cross-section: 0.14 mm ²	/ 100-100	706-2300
	Item no.: 706-2300/100-200 System cable; for Siemens S7-300; 2 x 16 digital inputs; Length: 2 m; Conductor cross-section: 0.14 mm ²	/ 100-200	706-2300
	Item no.: 706-2300/100-300 System cable; for Siemens S7-300; 2 x 16 digital inputs; Length: 3 m; Conductor cross-section: 0.14 mm ²	/ 100-300	706-2300
	Item no.: 706-2300/101-100 System cable; for Siemens S7-300; 16 digital inputs; Length: 1 m (1 MOhm); Conductor cross-section: 0.14 mm ²	/ 101-100	706-2300
	Item no.: 706-2300/101-200 System cable; for Siemens S7-300; 16 digital inputs; Length: 2 m; Conductor cross-section: 0.14 mm ²	/ 101-200	706-2300
	Item no.: 706-2300/101-300 System cable; for Siemens S7-300; 16 digital inputs; Length: 3 m; Conductor cross-section: 0.14 mm ²	/ 101-300	706-2300
	Item no.: 706-2300/200-100 System cable; for Siemens S7-300; 2 x 16 digital outputs; Length: 1 m (1 MOhm); Conductor cross-section: 0.14 mm ²	/ 200-100	706-2300
	Item no.: 706-2300/200-200 System cable; for Siemens S7-300; 2 x 16 digital outputs; Length: 2 m; Conductor cross-section: 0.14 mm ²	/ 200-200	706-2300
	Item no.: 706-2300/200-300 System cable; for Siemens S7-300; 2 x 16 digital outputs; Length: 3 m; Conductor cross-section: 0.14 mm ²	/ 200-300	706-2300
	Item no.: 706-2300/300-100 System cable; for Siemens S7-300; 16 digital inputs or outputs; Length: 1 m (1 MOhm); Conductor cross-section: 0.14 mm ²	/ 300-100	706-2300
	Item no.: 706-2300/300-200 System cable; for Siemens S7-300; 16 digital inputs or outputs; Length: 2 m; Conductor cross-section:		

	0.14 mm ²		706-2300
		7300-200	
	Item no.: 706-2300/300-300 System cable; for Siemens S7-300; 16 digital inputs or outputs; Length: 3 m; Conductor cross-section: 0.14 mm ²	7300-300	706-2300
	Item no.: 706-2300/301-100 System cable; for Siemens S7-300; 2 x 16 digital inputs or outputs; Length: 1 m (1 MOhm); Conductor cross-section: 0.14 mm ²	7301-100	706-2300
	Item no.: 706-2300/301-200 System cable; for Siemens S7-300; 2 x 16 digital inputs or outputs; Length: 2 m; Conductor cross-section: 0.14 mm ²	7301-200	706-2300
	Item no.: 706-2300/301-300 System cable; for Siemens S7-300; 2 x 16 digital inputs or outputs; Length: 3 m; Conductor cross-section: 0.14 mm ²	7301-300	706-2300
	Item no.: 706-7753/301-200 System cable; for WAGO-I/O-SYSTEM, 753 Series; 16 digital inputs or outputs; Length: 2 m; Conductor cross-section: 0.14 mm ²	7301-200	706-7753

Marking accessories

	Item no.: 2009-110 Marking strips; on reel; not stretchable; plain; snap-on type		2009-110
	Item no.: 709-177 Marking strips; on reel; 7.5 mm wide; not stretchable; plain; snap-on type		709-177
	Item no.: 709-178 Marking strips; on reel; 7.5 mm wide; not stretchable; plain; snap-on type		709-178
	Item no.: 709-196 Marking strips; for laser printer		709-196
	Item no.: 709-198 Marking strips		709-198

Downloads

Documentation

Additional Information

Disposal; Electrical and electronic equipment, Packaging	V 1.0.0	pdf 265.8 kB	Download
--	---------	-----------------	----------

CAD/CAE - Smart Data

CAD data

3D Download 704-2024	URL	Download
----------------------	-----	----------



Subject to changes.
